

### portable displays

easy and lightweight  
beautiful and functional  
portable display systems.

### textile printing

bright and eye-catching colors  
printed directly on textile media  
using latest sublimation technology.

### modular design

professional exhibition system,  
user-friendly and highly adaptable  
for multipurpose use.



your idea, our display



# Content



Roll-up

2

A very fast solution for displaying an advertisement in an indoor space. The printed material rolls inside the case and is thus protected during transportation.



Counter Desk

9

Depending on the available surface or the location where you have to present, you need one of our counters. Used for promotions in hypermarkets or as presentation desks at conferences,



Units

18

UNITS® foam furniture combines utility and imagination to build creative discussion spaces. Made of polyurethane foam elements, they are comfortable and easy to transport.



Stand

22

Easy to install low cost banner stands, people stoppers and brochure holders that offer a simple and functional solution to display your message and hold your catalogues.



Pop-up Tent

28

Here is the perfect solution for your outdoor events! Thanks to its expandable aluminium structure, strong hexagonal profile and waterproof canopy material, the Pop-up Tent is great for regular use regardless of weather conditions.



Pop-up

6

Large images draw attention. Pop-up walls are very useful in creating a custom background for a conference or partitioning an exhibition stand. They are easy to install and transport. To install a pop-up no qualified staff or additional tools are needed.



Wave

12

A spectacular new display system ideal for exhibitions, presentations, conferences, product launches or meetings. The one piece sublimation printed textile fabric ensures a seamless and beautiful display.



EasyCubes

20

EasyCubes® is a revolutionary modular system that allows you to build POSM displays, floors and exhibit areas using prefabricated elements.



Flag

25

Vision flags are portable and easy to install, perfect for advertising campaigns or other outdoor or indoor events. They are made from durable anti-corrosive fiberglass and tested in the toughest weather conditions to last a long time.



Exhibition solutions

30

Vision wall systems are modular and can be easily adapted to any exhibition space. You can choose from over 100 predefined solutions with the possibility of a 3D preview before execution.



# Roll-up Vision

ID: RU-060, RU-085, RU-100, RU-120, RU-150

Features: Aluminium casing, superior holding rod with click fastening system, three-jointed support bar, textile carry bag

Available colors: Silver

Indoor	Setup	Best seller	Warranty

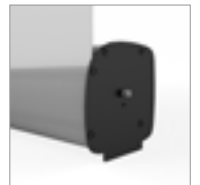

The VISION roll-up system is made of high quality aluminium elements and provides an excellent flatness to the printed advertising message. Mount the printed message using the superior bar on the support rod and your print surface will be tensioned and ready to attract customers. Roll the printed media back in the system when transporting so it will be protected from shocks, bumps or scratches.

“

We represent brands such as Durex, Air Wick, Vanish, Calgon, so working with us means that our needs are urgent and important to the success of campaigns. I was impressed to see that they have a very clear vision about brand communication and fully comply with our requirements.

All we can say is that we give Vision a strong recommendation for any customer or brand that wants to work with an efficient team.

”



Florentina Baciu  
Customer Marketing Manager  
Reckitt Benckiser





Roll-up Vision is available in 5 different sizes:

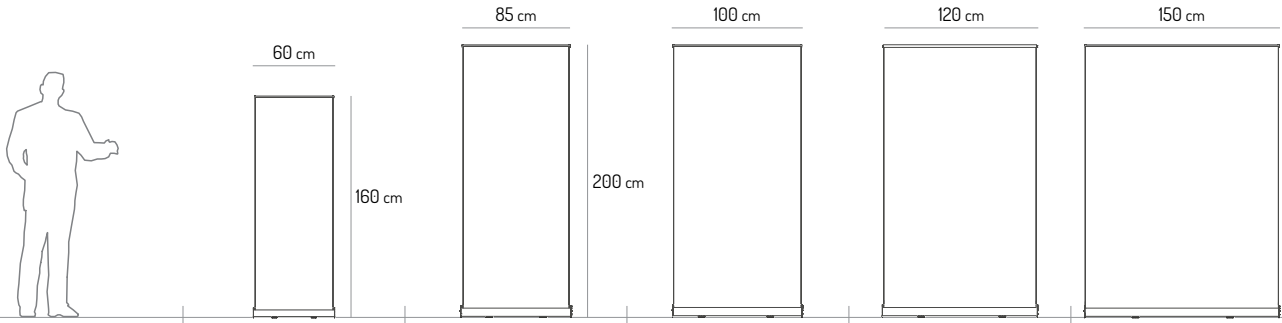

Model	Roll-up Vision 060	Roll-up Vision 085	Roll-up Vision 100	Roll-up Vision 120	Roll-up Vision 150
Specs					
Product id	RU-060	RU-085	RU-100	RU-120	RU-150
Print dimensions	60 x 160 cm	85 x 200 cm	100 x 200 cm	120 x 200 cm	150 x 200 cm
Weight	1.4 kg	2.0 kg	2.2 kg	3.2 kg	3.8 kg
Pcs./Package	10	10	10	6	6
Package dimensions	65 x 20 x 42 cm	90 x 20 x 42 cm	105 x 20 x 42 cm	125 x 22 x 30 cm	155 x 22 x 30 cm
Package weight	15 kg	21 kg	23.1 kg	20.1 kg	23.7 kg

RU-060

RU-085

RU-100

RU-120

RU-150







# Roll-up Vision Premium

ID: RL-085

Features: Aluminium casing, superior holding rod with click fastening system, three-jointed support bar, padded textile carry bag

<b>Print dimensions:</b>	<b>85 x 200 cm</b>
Weight:	2.6 kg
Available colors:	Silver



Indoor



Setup



Premium



Warranty

Ideal for high quality presentations in extravagant locations, this high performance roll-up display is also easy to mount or unmount. The special design of this display masks all the screws and bindings so that your printed media will look smooth. During transportation, the print is rolled inside the high quality aluminum support and is thus protected from shocks, bumps or scratches.

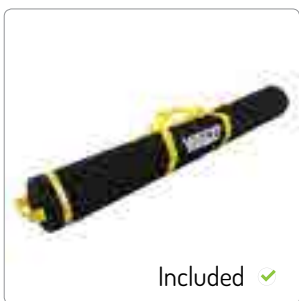
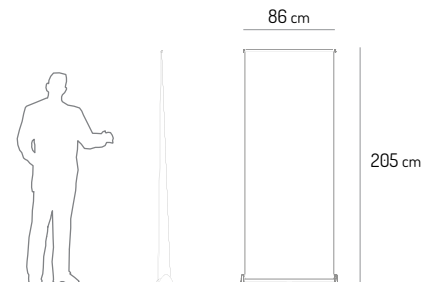

Included ✓

Padded roll-up textile bag  
ID: ASE-1B



Pieces per package:	6
Package dimensions:	87 x 34 x 23 cm
Package weight:	16.6 kg



# Roll-up Vision Double

ID: RD-085

Features: Aluminium casing, superior holding rods with click fastening systems, three-jointed support bar, textile carry bag

<b>Print dimensions:</b>	<b>85 x 200 cm x 2 sides</b>
Weight:	4.7 kg
Available colors:	Silver



Indoor	Setup	Impressive	Warranty

An excellent idea for fast and successful presentations. Just open the Roll-up display, hoist the two printed surfaces and everything is ready in less than 1 minute. During transportation, the printed media is rolled inside the high quality aluminium support and is thus protected from shocks, bumps or scratches.

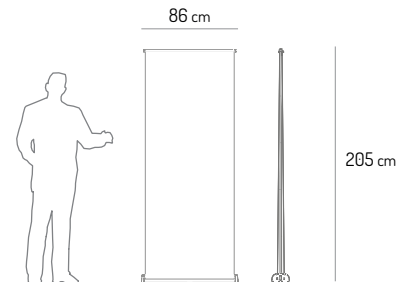

“ We are working with Vision for almost 4 years and at first, our attention was attracted by the competitive prices with which they entered the market. It's that 'best-value' any buyer of advertising is looking for.

To our satisfaction we found a supplier that not only gave us the best price, but the highest quality product. With promotions and new products that Vision has, we were able to distinguish ourselves from our competitors at trade fairs and within our resellers. Services that enhance our collaboration today are: innovation, quality, timeliness, helpfulness, cost and reliability.

We recommend Vision to any company that wants to buy advertising systems to the same standards as in Western Europe.



Alexandru Oprea  
National Sales Manager  
Rehau



Pieces per package:	4
Package dimensions:	89 x 25 x 36 cm
Package weight:	19.7 kg

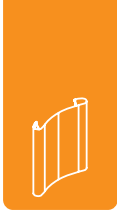

# Pop-up Vision Straight/Curved

ID: PP-32D, PP-33D, PP-34D / PP-32C, PP-33C, PP-34C

Features: Pop-up extendable system, vertical support beams, magnetic strip, PVC hangers, two 50W spotlights, textile trolley

Available colors: Silver



Indoor

Setup

Best seller

Warranty

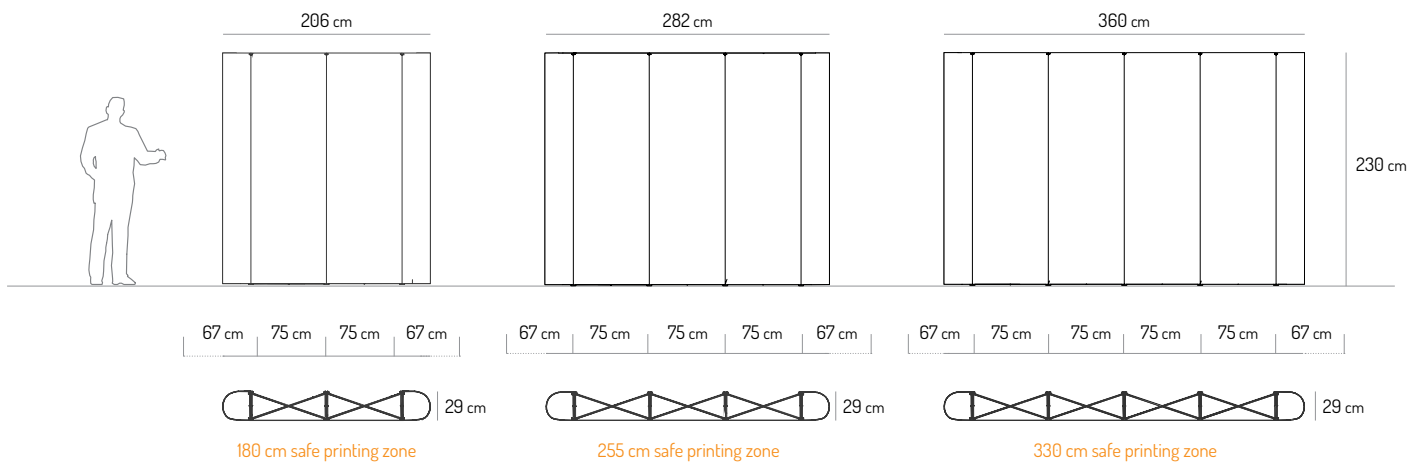

See all pop-up accessories on page 9

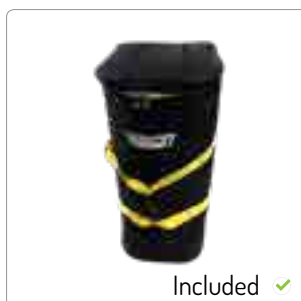

Textile trolley  
ID: ASE-2TT

Model Specs	Pop-up Vision 3x2 Straight	Pop-up Vision 3x3 Straight	Pop-up Vision 3x4 Straight
Product id	PP-32D	PP-33D	PP-34D
<b>Print dimensions</b>	<b>284 x 230 cm</b>	<b>359 x 230 cm</b>	<b>434 x 230 cm</b>
Weight	22 kg	26 kg	30 kg
Pcs./Package	1	1	1
Package dimensions	95 x 45 x 45 cm	95 x 45 x 45 cm	95 x 45 x 45 cm
Package weight	22.5 kg	26.5 kg	30.5 kg





# Pop-up Vision is available in 6 different standard sizes

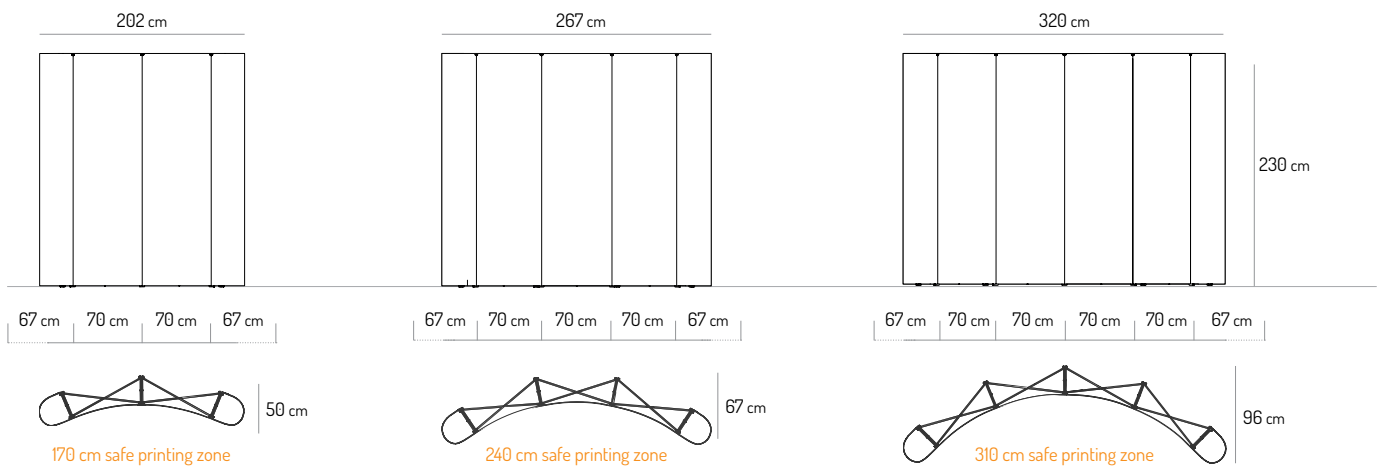

Model	Pop-up Vision 3x2 Curved	Pop-up Vision 3x3 Curved	Pop-up Vision 3x4 Curved
Product id	PP-32C	PP-33C	PP-34C
Print dimensions	274 x 230 cm	344 x 230 cm	414 x 230 cm
Weight	22 kg	26 kg	30 kg
Pcs./Package	1	1	1
Package dimensions	95 x 45 x 45 cm	95 x 45 x 45 cm	95 x 45 x 45 cm
Package weight	22.5 kg	26.5 kg	30.5 kg

This pop-up system (spider) is an ideal choice for presenting large advertisements due to its height (2.30 m). It is great for exhibitions, presentations, conferences, various meetings, etc.. It is a collapsible bar system that is mounted quickly, even by one person, without using additional tools. All necessary accessories are included in the carry case it comes in.



Graphic plates can be added to the back of the systems to make them double faced. The back plates have a width of 75 cm for straight pop-up systems and 82 cm for curved pop-up systems.



## Pop-up Accessories



### Textile Trolley

ID: ASE-2TT  
Dimensions: 85 x 40 x 36 cm  
Weight: 6.2 kg

The textile trolley is the easiest way to transport pop-up systems. Its padded walls protect the system and pvc strips from bumps and scratches.



### Pop-up Shelf

ID: ASE-MS  
Dimensions: 70 x 72 x 28 cm  
Dim. (unassembled): 7 x 73 x 38 cm  
Weight: 10.5 kg

The pop-up shelf is used for displaying products without taking up extra space. The shelf is secured in place by magnetic strips to the pop-up structure and is compatible with any VISION pop-up system that is straight.



### Pop-up Halogen Spotlight

ID: ASE-2SLH  
Dimensions: 59 x 17 x 6 cm  
Weight: 1.1 kg  
Color: 2800 K

The pop-up spotlight is used to increase visibility of your printed message on pop-up systems in low lighting conditions. This spotlight is compatible with any VISION pop-up system because it attaches directly to the top connecting rods.



### Pop-up LED Spotlight

ID: ASE-2SLL  
Dimensions: 59 x 17 x 6 cm  
Weight: 1.1 kg  
Color: 6000 K



# Pop-up Desk

ID: PPD-1, PPD-2C

Features: Expandable pop-up system, vertical rods, horizontal rods, 4 PVC strips, magnetic strip, wooden countertop, textile carry bag  
 Available colors: White, Black, Beech, Oak

Indoor

10min

Storage inside

1 YEAR

Fully customizable and elegant, with a carefully finished wooden countertop, Pop-Up Desk VISION is very inviting. The structure is similar to that of a pop-up system (spider). Consequently, it is expandable and easy to install and transport. The system comes in a textile carrying case. Area of use: exhibition stands, showrooms, conferences, events, receptions, etc. Position the "Desk Vision" display in front of any large Pop-Up display and it represents both an opportunity for additional advertising and a storage space for your promotional tools.

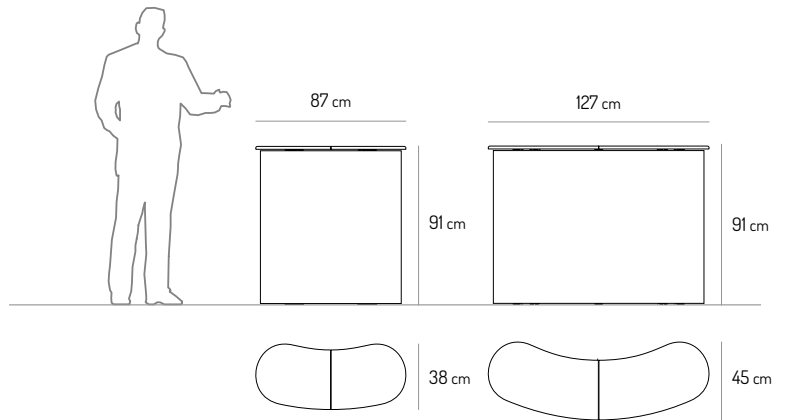

Model / ID	Pop-up Desk Mini PPD-1	Pop-up Desk Maxi PPD-2C
Print Dimensions (cm)	160 x 88	208 x 88
Weight (kg)	8	12.5
Pieces per package	1	1
Package Dimensions and Weight	103 x 41 x 14 cm 8.8 kg	103 x 41 x 21 cm 13.4 kg

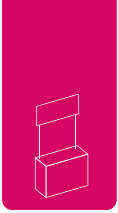

# Promoter Desk

ID: D-2D

Features: Personalizable plastic base and top, four metal tubes, three PVC counters (bottom, middle and top), carry bag

**Print dimensions (base):** 178 x 80 cm  
**Print dimensions (top):** 80 x 30 cm  
 Weight: 7.2 kg  
 Available colors: White



Indoor	Setup	Best seller	Warranty



The promoter desk represents an advertising product and at the same time an additional storage space for your promotional tools. Just place it in front of a pop-up display or wave system and setting up for your advertising campaign is complete! It can be easily mounted, even by a single person, and the printed media can be quickly attached to the body. It can be used for various activities: sampling, product presentations, etc.

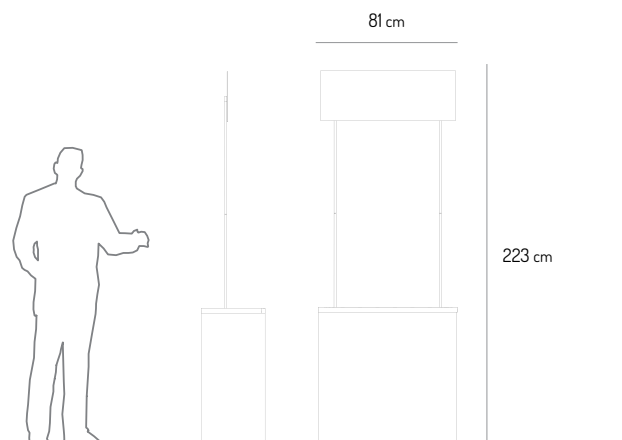

Pieces per package: 2  
 Package dimensions: 91 x 85 x 13 cm  
 Package weight: 15.4 kg



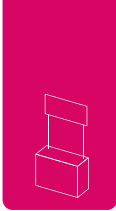

# Wave<sup>®</sup> Desk

ID: WVD-1 (Oval),  
WVD-2 (Square)

Features: aluminium bars, 2x wooden tops, carry case, custom printed fabric

Available colors: Silver

Indoor	Setup	Storage inside	Warranty

Fully customizable and elegant, with a carefully finished wooden counter top, VISION Wave<sup>®</sup> Desks are very inviting. They are easy to install and transport. Area of use: exhibition stands, showrooms, conferences, events, receptions, etc. It can be an opportunity for additional advertising and also a storage space for your promotional tools. The system comes in a textile carrying case.



360°  
display

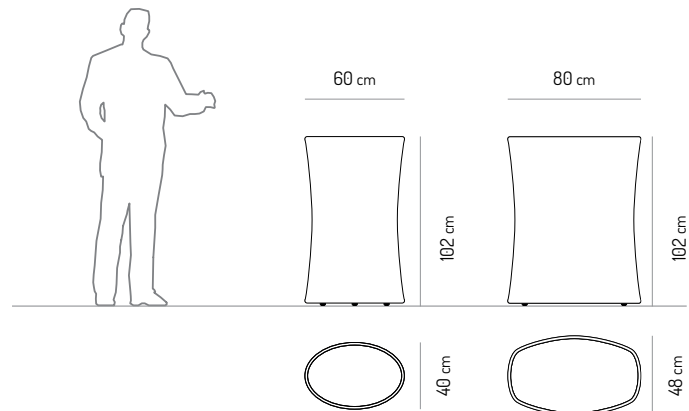
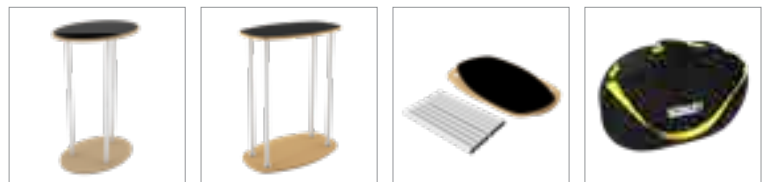

Model / ID	Wave Desk Oval WVD-1	Wave Desk Square WVD-2
Print Dimensions (cm)	158 x 107	215 x 107
Weight (kg)	7.4	11.1
Color	Black	Black
Package Dimensions and Weight	63 x 46 x 13 cm 8.1 kg	82 x 53 x 10 cm 12 kg





# Wave® Curved

ID: WV-265C, WV-325C

Features: Inter-connectable aluminium tubes, textile carry bag, custom printed fabric

Available colors: Silver

Indoor	Setup	Best seller	Warranty



Vision Wave® is a spectacular new display system ideal for exhibitions, presentations, conferences, product launches, meetings, etc. Being a series of inter-connecting aluminium elements that make up a frame designed to stretch the fabric graphic, your marketing message is displayed perfectly and can be printed on both sides. Part of the large wall family, the Vision Wave® is easy to mount and unmount (no tools needed) thanks to the one piece textile graphic that easily fits into place on the aluminium structure. A great solution for campaigns that need to change advertising messages often. We recommend two people for assembling.

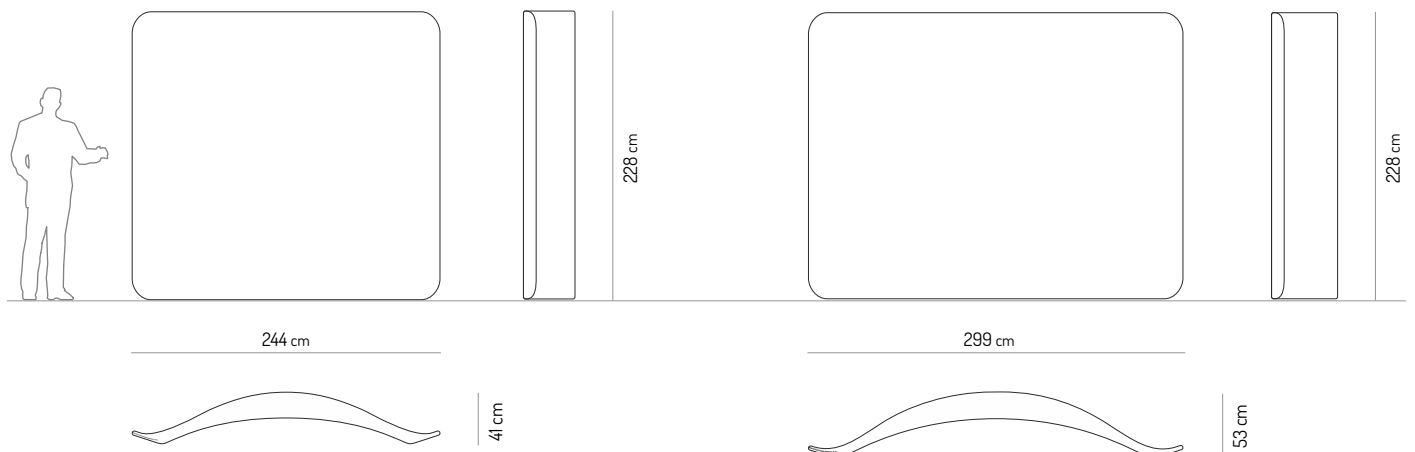





# Seamless fabric display



Custom printed fabric ✓



Specs Model / ID	Print Dimensions (cm)	Weight (kg)	Package Dimensions and Weight
Wave Curved WV-265C	265x228	7	132x35x19 8 kg
Wave Curved WV-325C	325x228	9	132x35x19 10 kg





# Wave<sup>®</sup> Curved C

ID: WV-480CC, WV-600CC

Features: Inter-connectable aluminium tubes, carry bag, custom printed fabric

Available colors: Silver



Indoor



Setup



Impressive



Warranty

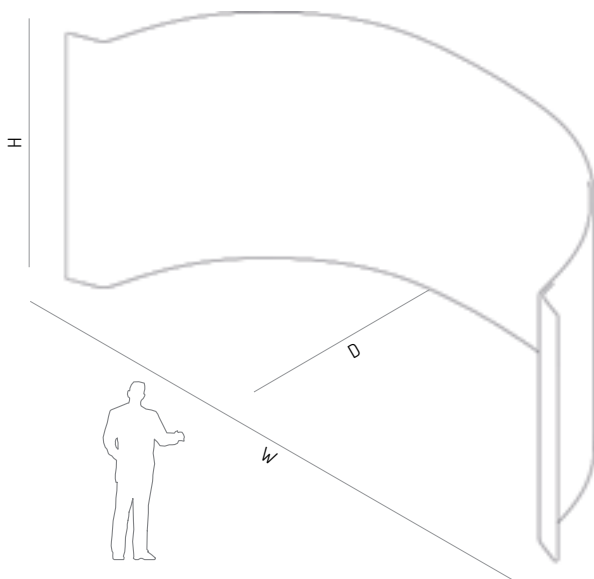

Specs Model / ID	W (Width, cm)	H (Height, cm)	D (Depth, cm)	Print Dimensions (cm)	Weight (kg)	Package Dimensions and Weight
Wave Curved C WV-480CC	356	228	127	480x228	14	132x35x19 cm 15 kg
Wave Curved C WV-600CC	529	228	191	600x228	18	132x35x19 cm 19 kg







# Wave® Banner 085

ID: WVB-085

Features: 8 inter-connectable aluminium bars, 2 aluminium feet, 2 plastic corner pieces, 1 horizontal support bar, carry bag

**Print dimensions:** 85 x 230 cm  
**Weight:** 3.2 kg  
**Available colors:** Silver



			
Indoor	Setup	Impressive	Warranty



Wave® Banner is a spectacular new display system ideal for exhibitions, presentations, conferences, product launches, meetings, etc. Being a series of inter-connecting aluminium elements that make up a frame designed to stretch the fabric graphic, your marketing message is displayed perfectly and can be printed on both sides. The Vision Wave Banner is easy to mount and unmount thanks to the one piece textile graphic that easily fits into place on the aluminium structure. A great solution for campaigns that need to change advertising messages often.

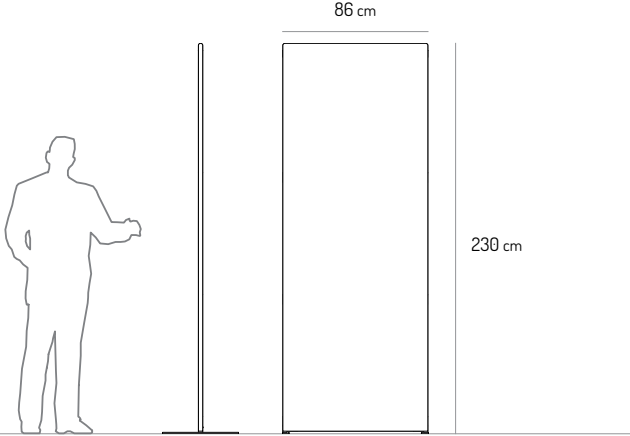

Pieces per package: 1  
Package dimensions: 91 x 12 x 12 cm  
Package weight: 3.6 kg

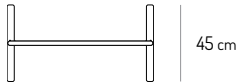



# Wave® Straight

ID: WV-100W\*, WV-100W\*-305H\*\*

\*Width from 100 cm to 600 cm. Can be increased by special order;

\*\*Height can be 230 cm or 305 cm;

Features: Inter-connectable aluminium tubes, aluminium feet, carry bag, custom printed fabric

Available colors: Silver



Indoor	Setup 10min	Best seller	Warranty 1 YEAR

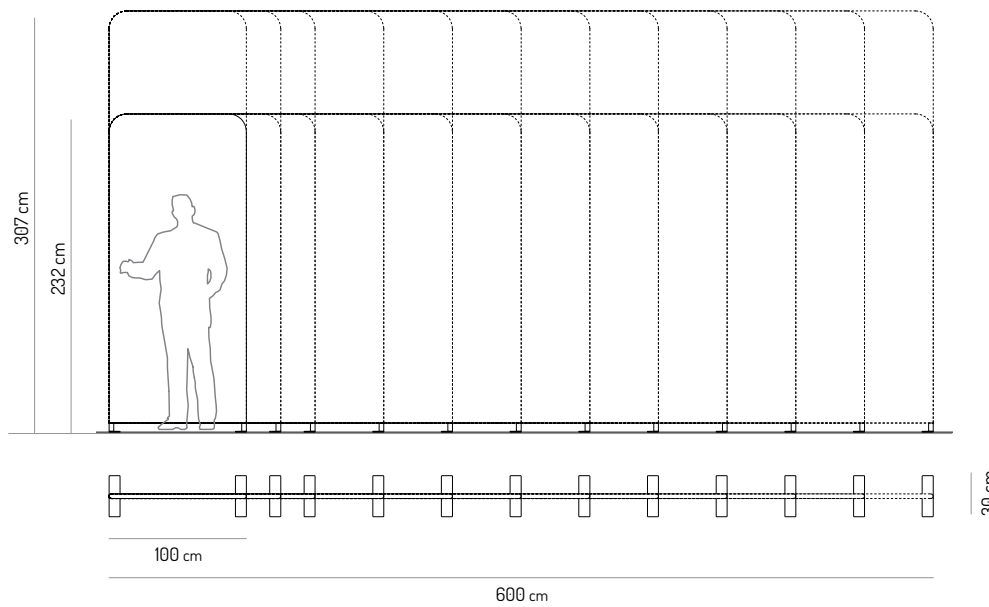
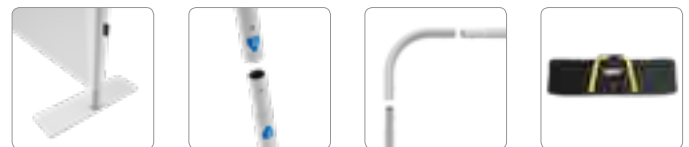

Specs Model / ID	W (Width, cm)	H (Height, cm)	D (Depth, cm)	Print Dimensions (cm)	Weight (kg)	Package Dimensions and Weight
Wave Straight 230H WV-W	100, 125, 150, 200...600 and higher by special order	230	3.2	According to custom design	According to requested dimension. Starting at 5 kg	132x35x19 Starting at 6 kg
Wave Straight 305H WV-W-H	100, 125, 150, 200...600 and higher by special order	305	3.2	According to custom design	According to requested dimension. Starting at 6 kg	132x35x19 Starting at 7 kg





# Wave® Angled

ID: WV-100W-235-265H, WV-150W-235-284H,  
WV-200W-235-304H, WV-300W-235-343H

Features: Inter-connectable aluminium tubes,  
aluminium feet, carry bag,  
custom printed fabric

Available colors: Silver



  
Indoor

  
Setup

  
Impressive

  
Warranty

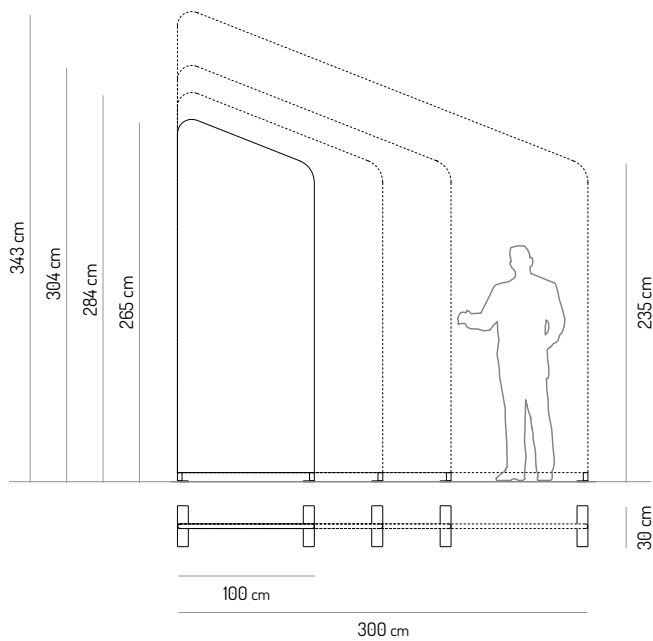

Model / ID	Wave 100 Angled WV-100W-235-265H	Wave 150 Angled WV-150W-235-284H	Wave 200 Angled WV-200W-235-304H	Wave 300 Angled WV-300W-235-343H
Specs				
Dimensions (cm)	100x265	150x284	200x304	300x343
Print Dimensions (cm)	100x265	150x284	200x304	300x343
Weight (kg)	5.5 kg	6.5 kg	7.5 kg	10.5 kg
Package Dimensions and Weight	132x35x19 cm 6.5 kg	132x35x19 cm 7.5 kg	132x35x19 cm 8.5 kg	132x35x19 cm 11.5 kg



# UNITS®

ID: UNITS-Cube, UNITS-Cylinder

Features: Custom foam shape, custom printed fabric

Available colors: Custom printed

Indoor	Setup	Impressive	Warranty

UNITS® foam furniture combines utility and imagination to build creative discussion spaces. Made of polyurethane foam elements, they are comfortable and easy to transport. Each unit is personalized with sublimation printed textile, protective fabric on the underside and a zipper for easy changing.



## UNITS® for kids



Model	Specs	Print Dimensions (cm)	Weight (kg)
UNITS® Cube Kids 30 x 30 x 30		5x ( 30 x 30 )	0.74 kg
UNITS® Cube 45 x 45 x 45		5x ( 45 x 45 )	2.5 kg
UNITS® Cylinder Kids 30 x 30		( 94 x 30 ) + ( 30 x 30 )	0.62 kg
UNITS® Cylinder 42 x 45		( 132 x 45 ) + ( 42 x 42 )	1.8 kg





# UNITS<sup>®</sup> for brands

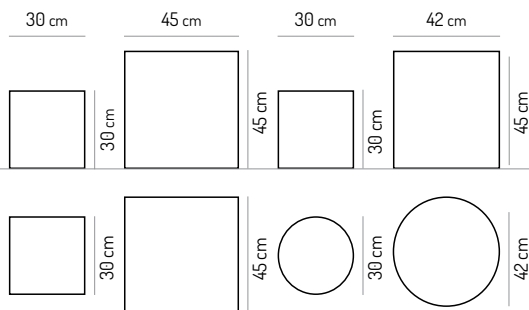
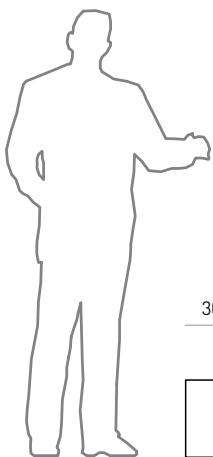





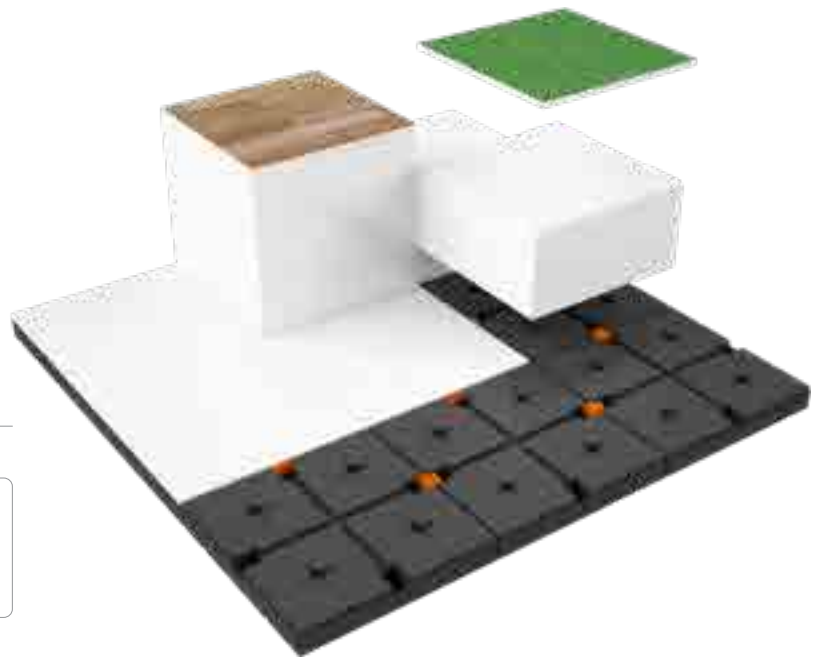

# EASYCUBES®

ID: EC-6600, EC-6601, EC-6602

Features: EasyCubes floor / cube / cover



			
Indoor/Outdoor	Setup	Impressive	Warranty

EasyCubes® is a revolutionary modular system that allows you to build POSM displays, floors and exhibit areas using prefabricated elements. Now you can customize and modernize the way you showcase your products with a unique presentation system. You can reorganize it quickly and easily, as opposed to a traditional, fixed display that can not be adapted to your flexibility needs.



Floor



Cube



Cover

Model \ Specs	Dimensions W x L x H	Weight (kg)	Standard color	Optional colors
EasyCubes® floor	40 x 40 x 5 cm	1 kg	Black	White
EasyCubes® cube	40 x 40 x 20 cm	2 kg	White	Black, Custom printed
EasyCubes® cover	40 x 40 x 1 cm	0,5 kg	White	Black, Custom printed



# Innovation! Prefabricated POSM!

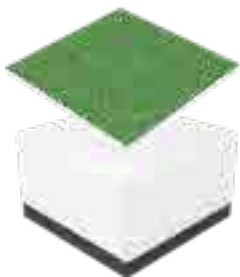



# Brochure Stand A4

ID: SB-2A (Brochure Stand A4)  
 SB-2B (Brochure Stand Z A4)  
 SB-3A (Brochure Stand Z Plexiglas A4)

Features: Brochure stand, textile carry bag

Available colors: Black (SB-2A, SB-2B), Silver (SB-3A)



Indoor



Setup



Best seller



Warranty

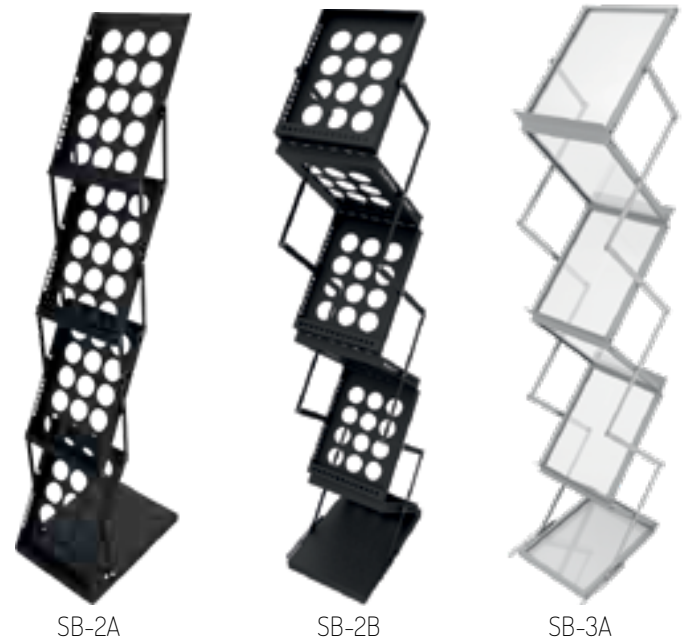

Designed for frequent use, it can be folded and unfolded easily in a matter of seconds. Easy to handle, the brochure stand can be moved from place to place for better visibility. It's simple and quick to install: lift and secure the locking mechanism to your desired height.

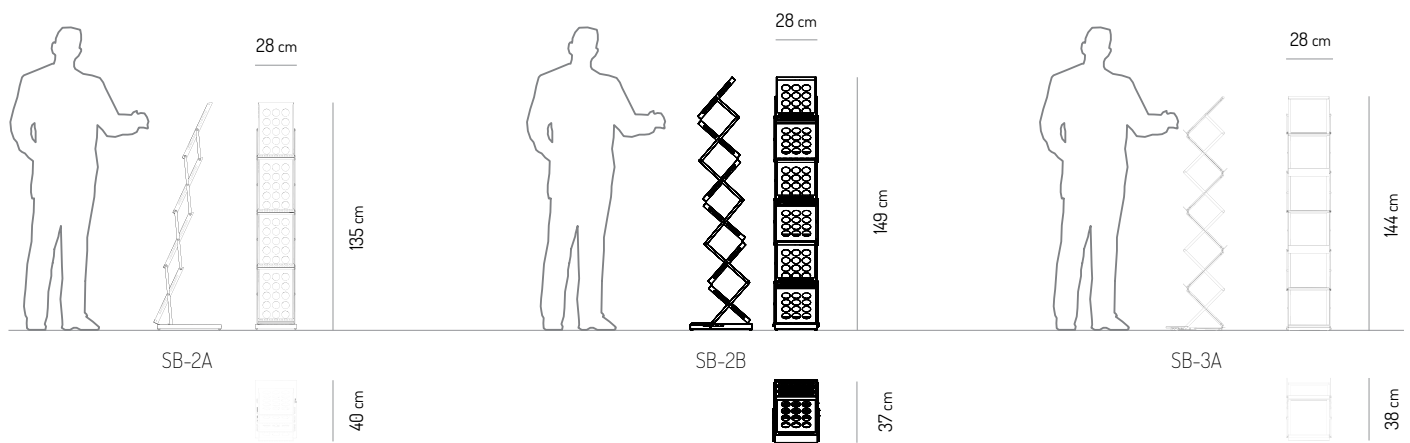

Specs Model / ID	W (Width, cm)	H (Height, cm)	D (Depth, cm)	Print Dimensions (cm)	Weight (kg)	Package Dimensions and Weight
Brochure Stand A4 SB-2A	28	135	40	21x29.7 (A4)	4.3	41x30x17 cm 4.8 kg
Brochure Stand Z A4 SB-2B	28	149	37	21x29.7 (A4)	6	35x30x24 cm 6.5 kg
Brochure Stand Z Plexiglas SB-3A	28	144	38	21x29.7 (A4)	6	50x36x18 6.5 kg





# A-Board Vision A1 / B2

ID: AB-A1 / AB-B2

Features: A-board system, 2 x anti glare PVC film  
 Available colors: Silver



Indoor



Setup



Best seller



Warranty

The A-board VISION is one of the most commonly used outdoor systems. Also referred to as a people stopper, it can be effortlessly folded and stored. Changing the printed message is fast and easy thanks to its click-frames. For added protection, the package includes two pieces of anti glare transparent PVC film.



Model	A-board Vision A1	A-board Vision B2
Product id	AB-A1	AB-B2
Print dimensions	84.1 x 59.4 cm (A1)	70.7 x 50 cm (B2)
Weight	7 kg	5 kg
Pcs./Package	1	1
Package dimensions	120 x 69 x 10 cm	108 x 58 x 10 cm
Package weight	7.4 kg	5.9 kg

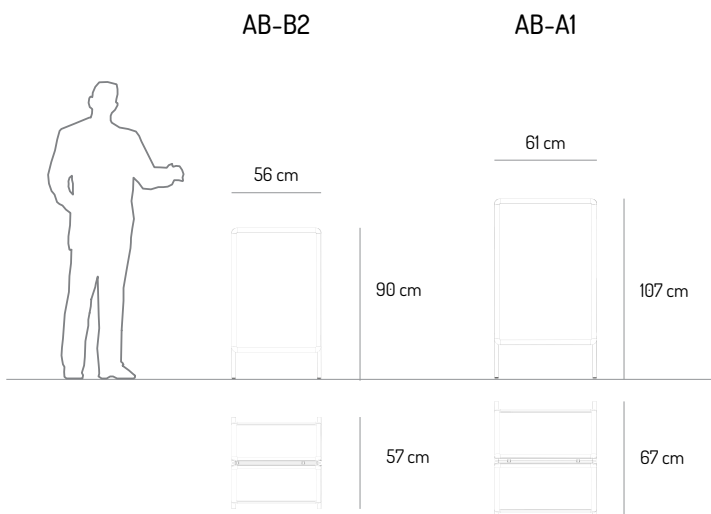



# A-board Spring WB A1

ID: AB-6B

Features: A-board system, 2 x anti glare PVC film, 2 x springs, water base packaged separately

**Print dimensions:** 84.1 x 59.4 cm (A1)  
**Weight:** 13.7 kg  
**Available colors:** Silver

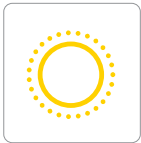

Outdoor



Setup

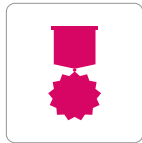

Premium



Warranty



The system is mounted using two resistant springs on a water base for extra weight and stability against wind. The swaying motion of the printed message ensures the system will not tip over no matter how bad the weather is.

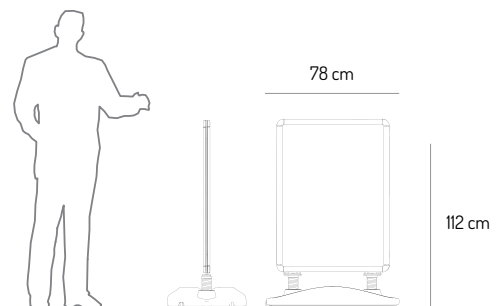

Pieces per package: 1  
 Package dimensions: 96 x 69 x 7 cm (display) + 83 x 51 x 16 cm (base)  
 Package weight: 14.2 kg

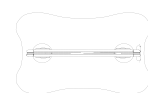

47 cm





# Mast Flag

ID: ST-3

Features: Telescopic mast, mast connector rings, water base packaged separately including four connecting elements plus accessories

**Print dimensions:** 110 x 370 cm  
**Weight:** 12.5 kg  
**Available colors:** Silver



Outdoor	Setup	Impressive	Warranty



The flag's base is a plastic tank that can be filled with water or sand for better stability. The flag pole is made of aluminum and is mounted on a frame that resembles that of an umbrella to ensure stability. It is an excellent way for outdoor promotion because the graphics are visible from a distance.

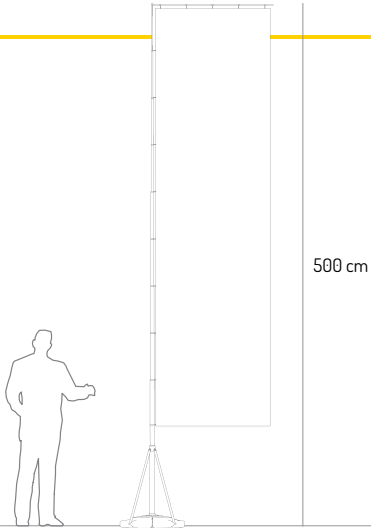

Pieces per package: 1  
Package dimensions: 170 x 12 x 12 cm (mast) 81 x 38 x 42 (base)  
Package weight: 13.3 kg



# Beach flags



Features: Interconnectable fiberglass rods, carry bag, base sold separately

Available colors: Gray



Indoor/Outdoor



Setup



Best seller



Warranty



These types of advertising flags will certainly attract attention towards your company and products. Made of high quality fiberglass, they are ideal for car dealers, real estate developers, restaurants, cafes, malls and more. Being lightweight and portable, these flags can be moved without effort because they do not require anchoring. Base sold separately.



210 cm



265 cm



315 cm



410 cm



260 cm



325 cm



Specs Model	Product id	Print dimensions	Weight	Pcs./ Package	Package dimensions	Package weight
Teardrop flag S	ST-1S	80 x 175 cm	0.9 kg	20	83 x 22 x 20 cm	11 kg
Teardrop flag M	ST-1M	100 x 220 cm	1.0 kg	20	99 x 22 x 20 cm	14.6 kg
Teardrop flag L	ST-1L	150 x 275 cm	1.3 kg	20	122 x 24 x 21 cm	18.3 kg
Teardrop flag XL	ST-1XL	160 x 365 cm	1.5 kg	10	123 x 20 x 19 cm	12.5 kg
Feather flag S	ST-2S	70 x 215 cm	0.9 kg	20	83 x 22 x 20 cm	11 kg
Feather flag M	ST-2M	70 x 280 cm	1.0 kg	20	99 x 22 x 20 cm	14.6 kg
Feather flag L	ST-2L	80 x 375 cm	1.3 kg	20	122 x 24 x 21 cm	18.3 kg
Feather flag XL	ST-2XL	90 x 485 cm	1.5 kg	10	123 x 20 x 19 cm	12.5 kg
Square flag S	ST-4S	79 x 163 cm	0.5 kg	10	112 x 23 x 16 cm	6.1 kg
Square flag M	ST-4M	79 x 263 cm	0.7 kg	20	152 x 25 x 16 cm	14 kg
Square flag L	ST-4L	79 x 363 cm	1.0 kg	10	145 x 25 x 16 cm	10.5 kg
Square flag XL	ST-4XL	79 x 463 cm	1.2 kg	10	145 x 25 x 16 cm	12.5 kg

Base sold separately:



Spike Flag Base  
ID: ASE-3A

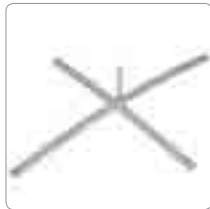

Cross Flag Base Econo  
ID: ASE-3D



Water Bag  
ID: ASE-3C

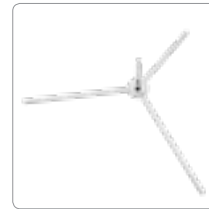

Flag Base Premium  
ID: ASE-3B



Water Base  
ID: ASE-3G

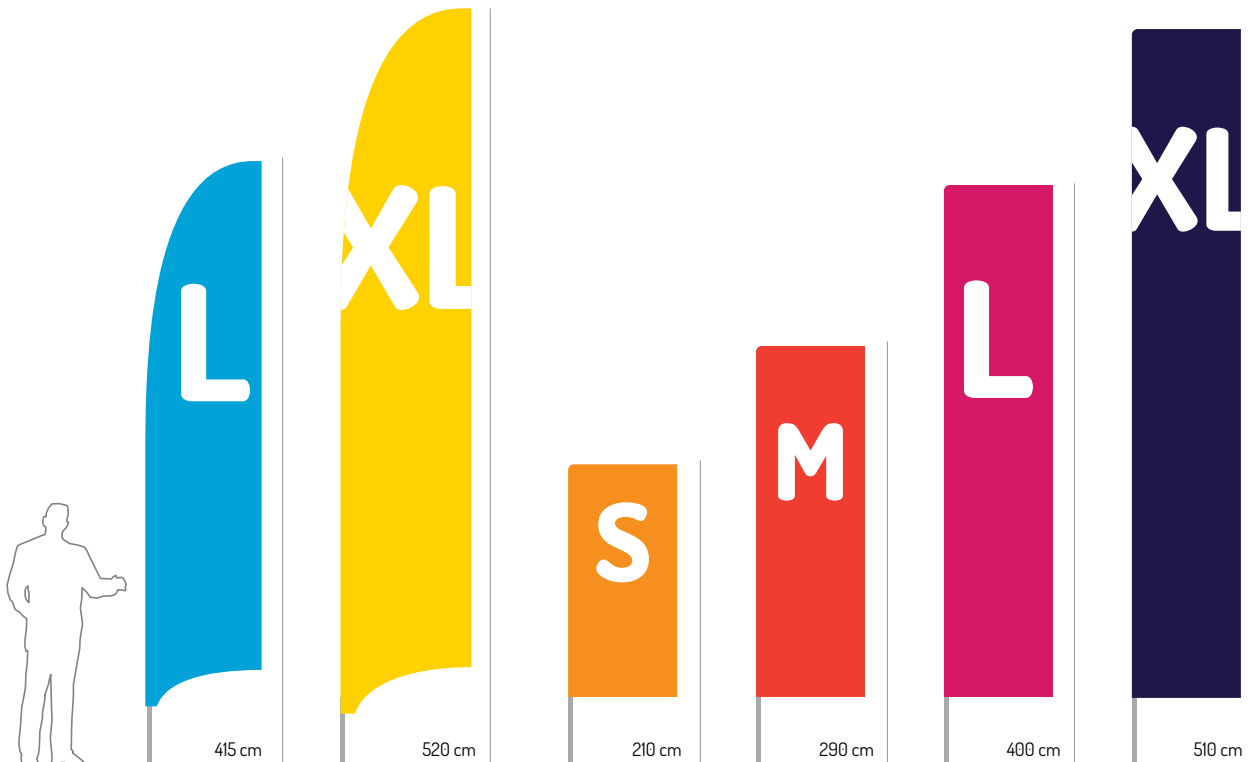



# Pop-up Tent

ID: TN-300, TN-450, TN-600

Features: Extendable aluminium system, canopy

Available colors: Canopy: White/Black/Red/Blue/ Green/Yellow/Custom print



Indoor/Outdoor	Setup	Impressive	Warranty

The Pop-up Tent portable pavillion is a perfect solution for your outdoor events. Thanks to its expandable aluminium profile system it is easy to transport and assemble, without additional tools. The weatherproof structure and waterproof canopy material allows for regular use regardless of outdoor conditions. The height can be adjusted according to your preference thanks to the easy to use click system.



Specs	Model	Pop-up Canopy Tent 300 x 300 cm	Pop-up Canopy Tent 300 x 450 cm	Pop-up Canopy Tent 300 x 600 cm
	Product id		TN-300	TN-450
Top side print dimensions		300 x 178 cm	300 x 178 cm	300 x 178 cm
Top center print dimensions		300 x 178 cm	450 x 178 cm	600 x 178 cm
Side flaps print dimensions		300 x 32 cm	300 x 32 cm	300 x 32 cm
Center flaps print dimensions		300 x 32 cm	450 x 32 cm	600 x 32 cm
Side walls print dimensions		300 x 208 cm	300 x 208 cm	300 x 208 cm
Center walls print dimensions		300 x 208 cm	450 x 208 cm	600 x 208 cm
Pcs./Package		1	1	1
Package dimensions		163 x 30 x 30 cm	163 x 30 x 40 cm	163 x 30 x 50 cm
Package weight		16.8 kg	21 kg	28,6 kg



# Expand your marketing outdoors!



## Scan the QR code to access our free 3D tent configurator

Standard canopy colors:



295 cm



For the canopy you can choose one of the standard colors ( white, black, red, blue, green, yellow ) or opt for a full custom graphic.

445 cm

Available accessories:



For extra protection against wind you can add some foot weights. They are stackable and weigh 7 kg each.

595 cm

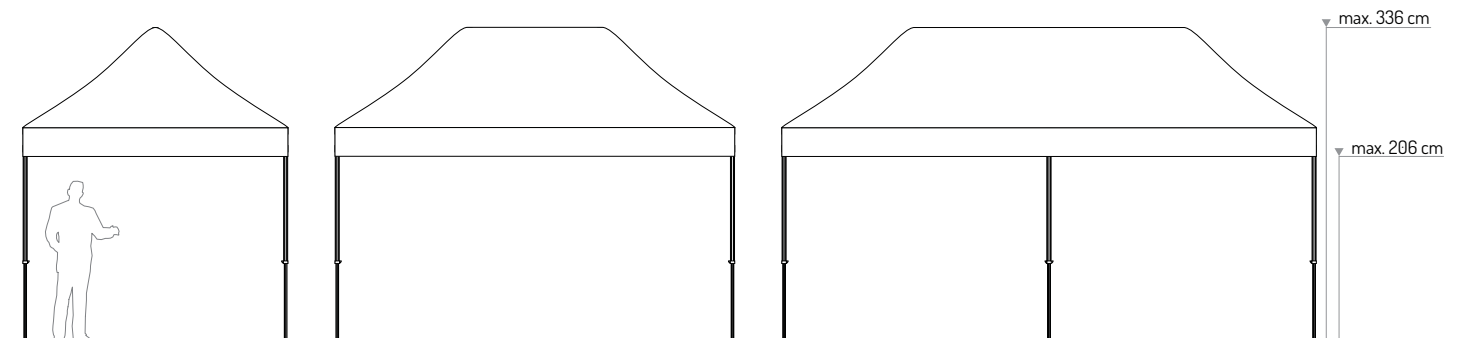





ideas

# Exhibition Stands

12 sqm booth layout (3mx4m)

12m<sup>2</sup>

This setup includes:

- 1 x Wave Straight Volume WV-150W-355H-30D
- 1 x Wave Angled WV-300W-235-343H
- 1 x Wave Desk Square WVD-2
- 2 x Wave 150W Spotlight Halogen



36 kg  
3 bags



## Why exhibit at a fair?



Contacting clients through online promotions and printed advertisement both have a downside: they are impersonal. As opposed to that, exhibiting at a fair and presenting the products/services directly to the public allows you to have a more personal approach to the client and gives you the opportunity to differentiate yourself from other similar businesses.



This setup includes:

- 1 x Wave Straight Volume WV-125W-305H-30D
- 2 x Wave Straight WV-300W
- 1 x Wave Desk Oval WVD-1
- 2 x Brochure Stand Plexiglas SB-3A
- 4 x Wave 150W Spotlight Halogen



52 kg  
6 bags



This setup includes:

- 1 x Wave Angled Volume WV-200W-235-304H-30D
- 1 x Wave Angled WV-200W-235-304H
- 1 x Wave Straight WV-100W
- 1 x Wave Straight WV-300W
- 2 x Wave Desk Oval WVD-1
- 1 x Wave TV/Shelf Stand WV-TV+Shelf
- 1 x Wave Shelf Stand WV-Shelf
- 4 x Wave 150W Spotlight Halogen



72 kg  
8 bags





ideas



This setup includes:

- 1 x Wave Straight Volume WV-300W-305H-30D
- 1 x Wave Straight WV-300W
- 1 x Wave Arc WV-ARCM-100W-305H-300D
- 1 x Wave Desk Oval WVD-1
- 2 x Wave Shelf Stand WV-Shelf
- 8 x Wave 150W Spotlight Halogen



81 kg  
6 bags



This setup includes:

- 1 x Wave Round Volume WVR-300W-305H-30D
- 1 x Wave Straight WV-200W
- 1 x Wave Straight WV-300W
- 1 x Wave Desk Oval WVD-1
- 1 x Wave TV/Shelf Stand WV-TV+Shelf
- 1 x Bochure Stand Plexiglas SB-3A
- 3 x Wave 150W Spotlight Halogen



55 kg  
6 bags

### Strengthen your brand image



Being present at an event specialized in your industry will increase the client's trust in your company's products/services, and a strong company image will always inspire trust. If you are a service provider, a fair gives you the opportunity to present your portfolio, your experience and abilities, and discuss with your potential clients face-to-face.



This setup includes:

- 1 x Wave Straight Volume WV-125W-305H-30D
- 1 x Wave Arc WV-ARCM-100W-305H-400D
- 1 x Wave Straight WV-200W
- 1 x Wave Straight WV-300W
- 1 x Wave Desk Oval WVD-1
- 5 x Wave 150W Spotlight Halogen



56 kg  
5 bags



This setup includes:

- 1 x Wave Straight Volume WV-100W-355H-30D
- 1 x Wave Straight WV-400W-305H
- 1 x Wave Desk Square WVD-2
- 1 x Brochure Stand Plexiglas SB-3A
- 4 x Wave 150W Spotlight Halogen



45 kg  
4 bags



ideas

# Exhibition Stands

18 sqm booth layout (3mx6m)



This setup includes:

1 x Wave Straight Volume WV-125W-355H-30D  
2 x Wave Arc L WV-ARCL-100W-305H-275D

1 x Wave Straight WV-600W-305H  
1 x Wave Desk Square WVD-2  
5 x Wave 150W Spotlight Halogen



65 kg  
5 bags

## Types of exhibition stands



Design can range from economy, if your only interest is to present your product, to very complex and imposing when you are looking to strengthen your brand's image. Modular exhibition stands can adapt to various spaces and are usually extensible or pliable which reduces the cost of transport and installation (they can be installed without a specialized team).

This setup includes:

1 x Wave Straight Volume WV-200W-305H-30D  
1 x Wave Arc WV-ARCM-100W-305H-300D  
1 x Wave Straight WV-400W  
1 x Wave Straight WV-300W  
1 x Wave Desk Square WVD-2  
2 x Wave TV/Shelf Stand WV-TV+Shelf  
8 x Wave 150W Spotlight Halogen



83 kg  
6 bags





18m<sup>2</sup>

This setup includes:

- 2 x Wave Straight Volume WV-100W-355H-60D
- 1 x Wave Straight WV-300W
- 1 x Wave Straight WV-600W
- 1 x Wave Desk Square WVD-2
- 2 x Brochure Stand Z A4 Plexiglas
- 6 x Wave 150W Spotlight Halogen



79 kg  
7 bags



This setup includes:

- 2 x Wave Straight Volume WV-300W-230H-30D
- 1 x Wave Straight WV-400W-305H
- 2 x Wave Desk Square WVD-2
- 7 x Wave 150W Spotlight Halogen



67 kg  
5 bags



This setup includes:

- 1 x Wave Straight Volume WV-100W-305H-30D
- 1 x Wave Round Volume WVR-300W-305H-30D
- 1 x Wave Tower WVT-60
- 1 x Wave Straight WV-150W
- 2 x Wave Straight WV-300W
- 1 x Wave Desk Square WVD-2
- 4 x Wave Shelf WV-Shelf-100
- 8 x Wave 150W Spotlight Halogen



95 kg  
8 bags







# Exhibition Stands

50 sqm booth layout (5m x 10m)



This setup includes:

- 1 x Wave Straight Volume WV-300W-305H-100D
- 1 x Wave Straight WV-700W
- 1 x Wave Straight WV-200W
- 2 x Wave Hover WV-HOVBOX-200W-50H-200D

- 2 x Wave Desk WVD-200W-100H-30D
- 1 x Wave TV/Shelf Stand WV-TV+Shelf
- 2 x Wave Shelf Stand WV-Shelf
- 22 x Wave 150W Spotlight Halogen



136 kg  
10 bags

## Packing and unpacking



Depending on how long the event takes, the organizer will give the exhibitors a certain amount of time for installation and removal of exhibition stands (this can range from days to hours). Make sure you finish both activities in time. Modular stands are much easier to set up and pack / unpack.

This setup includes:

- 1 x Wave Straight Volume WV-300W-305H-100D
- 2 x Wave Straight WV-500W
- 1 x Wave Hover WV-HOVBOX-500W-50H-200D
- 4 x Wave Desk WVD-200W-100H-30D
- 3 x Wave Desk WVD-100W-100H-30D
- 1 x Wave TV Stand WV-TV
- 22 x Wave 150W Spotlight Halogen



156 kg  
12 bags





50m<sup>2</sup>



This setup includes:

- 1x Wave Straight Volume WV-500W-305H-100D
- 1x Wave Straight WV-1000W-305H
- 1x Wave Arc WV-ARCM-100W-305H-400D
- 1x Wave Hover WV-HOVBOX-200W-50H-400D
- 1x Wave Desk WVD-300W-100H-30D
- 3 x Wave Desk WVD-200W-100H-30D
- 21 x Wave 150W Spotlight Halogen



156 kg  
8 bags



This setup includes:

- 1x Wave Straight Volume WV-300W-305H-100D
- 1x Wave Straight WV-700W
- 1x Wave Curved WV-600S
- 2 x Wave Desk WVD-200W-100H-30D
- 1x Wave Desk WVD-100W-100H-30D
- 3 x Wave TV/Shelf Stand WV-TV+Shelf
- 15 x Wave 150W Spotlight Halogen



132 kg  
9 bags



This setup includes:

- 2 x Wave Straight Volume WV-150W-305H-200D
- 1x Wave Hover WV-HOVBOX-200W-50H-500D
- 2 x Wave Desk WVD-200W-100H-30D
- 2 x Wave Desk WVD-100W-100H-30D
- 20 x Wave 150W Spotlight Halogen



123 kg  
7 bags



# Services

## ARTWORK GUIDELINES

Our graphic team is specialized in personalizing exhibition systems and in creating print layouts for posters and billboards. Your files will always be carefully checked and adapted to your desired system dimensions and print processes. Rest assured, we strive to deliver the best end product you can get. We accept all common professional graphic software formats such as JPEG, TIFF, EPS, PDF etc.

For more details please download our artwork guidelines pdf file.

## 3D STAND DESIGN

Whether you're looking for a way to display your message during a conference or you're taking part in a trade show, you have over 100 predefined exhibition stand layouts to choose from or we can create a custom layout just for you. Our experienced designer team will help carry out your project.

Also, we offer the possibility to preview your exhibition stand for free using a 3d rendering before printing.

## ASSEMBLY

Our products are designed to be assembled without the use of extra tools.

This assures our prices will always be low, saving you money. However, we can provide a team of professionals to assemble complex structures for you on site.

This service is available in areas that have a VISION representative. For further information please read our terms & conditions page.

## LARGE FORMAT PRINTING

We started this fascinating journey into the world of colors with the help of Canon. We have the necessary technology for a large printing number in a short amount of time but most important, we have a trained production team ready to tackle any chore. You'll always receive quality products at very good prices.

We are specialized in personalizing exhibition systems and printing posters, billboards, backlit films for lightbox signage, self-adhesive vinyl film and any other printable material used in advertising campaigns.

We also print directly on textile media through sublimation technology. Bright, UV resistant colors and the possibility of folding and washing these materials are just some of the advantages of using textile based materials for your marketing campaigns.

## PACKING AND DELIVERY

We act local, but think global. We offer international transport for our clients.

The shipments are provided and secured by private, reliable delivery companies or by partner companies in countries with representatives.

To assure the highest quality possible, our products are carefully packaged for a safe delivery.



For orders and other useful  
information please contact your  
local distributor:





All products  
have a one year warranty.